

MEVPM200H

Voltage / Frequency	Power	Insulation Class	Average Flow Rate	Max Pressure	Noise @ 20cm (environmental noise ≤ 45 dB(A))	Working Temp	Working Mode	Safety Approval
Volt/Hz	Watt	--	cc/min	Bar	dBA	ΔT (K)	on/off(min)	--
240/50	18	F	160-240	2-4	≤ 58	105	Can work continuously	TUV
230/50	18	F						
220/50	18	F						
220/60	18	F						
120/60	18	F						
100/50-60	18	F						UL/CUL

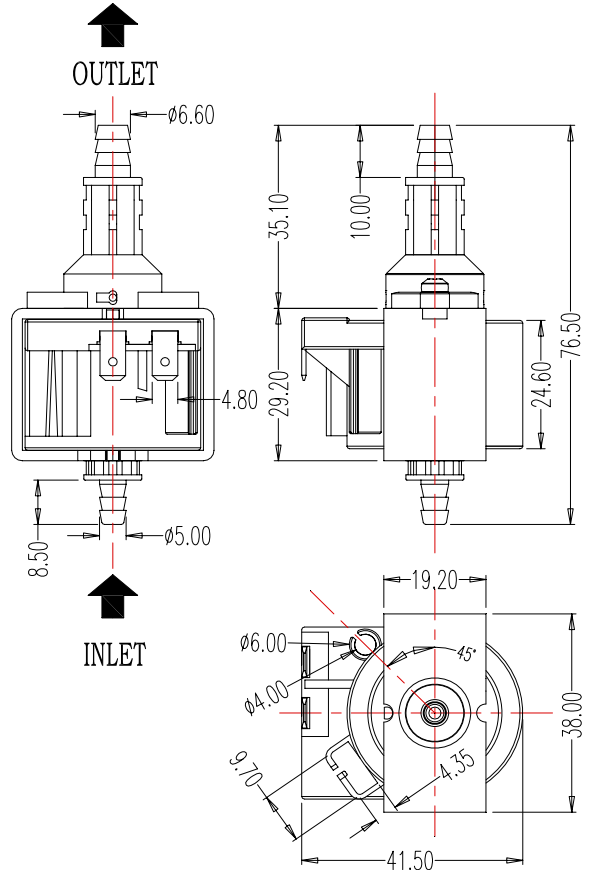
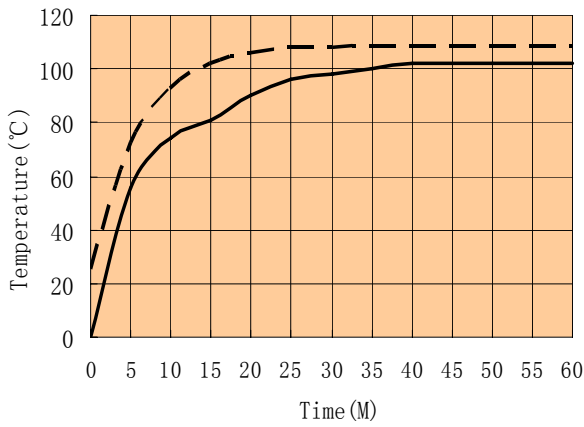
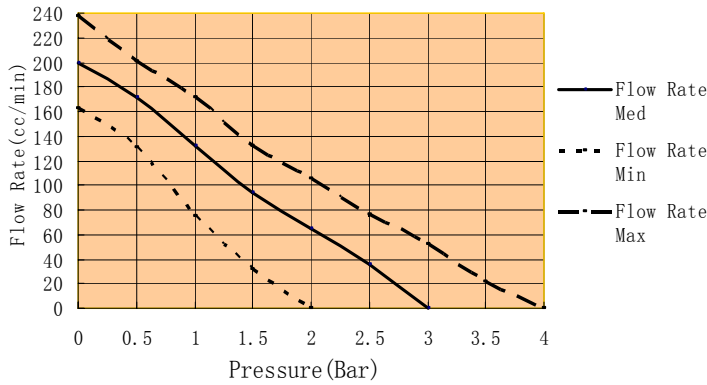

Feature	Material	Application
Alternating current	Plastic parts: PA 66	Espresso Coffee Machines
Ideal fluid: Water	Piston: SUS	Carpet Cleaners
Self priming at 0 Bar	Springs: SUS	Vacuum Cleaners
Integrated diode	Plating: Zn	Ironing Presses
Electrical connections: 4.8 x 0.8	Rubber parts: Nitrile	System Irons
Thermal cutout pocket	Diode: 1N4007	Steam Generators
Outlet in plastic	Terminals: Tinned Brass	Vending Machines
Automated production and inspection	Bobbin: PA 66	Cooling Systems
Full detailed electrical and hydraulic inspection	Encapsulation: PA 66	Air Conditioners

All Solenoid Pumps, Valves and Accessories are ROHS approved by SGS